



Radio / Cassette

Lexington C32 St. Louis C32

Operating instructions





<http://www.blaupunkt.com>

 **BLAUPUNKT**

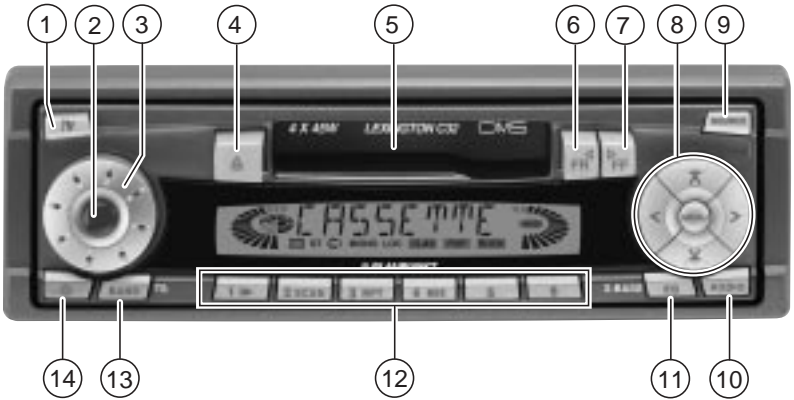
Open here
Ouvrir s.v.p.
Por favor, abrir
Favor abrir



CONTROLS

- ①  button to release the control panel
- ② Button to switch the unit on/off
- ③ Volume control
- ④  Cassette eject
- ⑤ Cassette compartment
- ⑥ **FR** button, fast tape winding
- ⑦ **FF** button, fast tape winding
- ⑧ Arrow buttons
MENU button, to open the basic settings menu
- ⑨ **SOURCE** button, to select the CC, radio and CD changer sources
- ⑩ **AUDIO** button, to adjust the bass, treble, balance and fader settings (Balance und Fader)
- ⑪ Short press: **EQ** button, to select the sound presets
Long press: **X-BASS**, X-Bass function
- ⑫ Keys **1 - 6**
- ⑬ Short press: **BAND** button, to select the FM memory bank and the AM waveband, source selection to radio mode
Long press: **TS**, to start the Travelstore function.
- ⑭  button, to display the time

Notes and accessories	6	Selecting tracks	12
Road safety	6	Fast track selection	12
Installation	6	Fast searching (audible)	12
Accessories	6	Repeating individual tracks or whole CDs (REPEAT)	12
Removable control panel	7	Random track play (MIX)	13
Theft protection	7	Scanning all tracks on all CDs (SCAN)	13
Detaching the control panel	7	Pausing playback (PAUSE)	13
Attaching the control panel	7	Clock - Time	14
Switching on/off	8	Displaying the time	14
Adjusting the volume	8	Setting the clock	14
Setting the power-on volume	8	Selecting 12/24-hour clock mode ..	14
Instantaneously reducing the volume (mute)	8	Displaying the time when the unit is off and the ignition is on	14
Mute while telephoning	9	Sound and volume distribution settings	15
Radio mode	9	Adjusting the bass	15
Switching to radio mode	9	Adjusting the treble	15
Selecting the frequency band / memory bank	9	Adjusting the balance settings	15
Tuning into a station	10	Adjusting the fader settings	15
Setting the sensitivity of station seek tuning	10	Equalizer and X-BASS	16
Storing station presets	10	X-BASS	16
Storing stations automatically (Travelstore)	10	Selecting preset sound effect	16
Listening to station presets	10	Specifications	17
Cassette mode	11	Amplifier	17
Cassette playback	11	Tuner	17
Switching over the playing side of the tape	11	CC	17
Fast tape winding	11	Pre-Amp Out	17
Cassette eject	11	Installation instructions	60
CD changer mode	12		
Switching to CD changer mode	12		
Selecting CDs	12		

NOTES AND ACCESSORIES

Thank you for deciding to use a Blaupunkt product. We hope you enjoy using this new piece of equipment.

Please read these operating instructions before using the equipment for the first time. The Blaupunkt editors are constantly working on making the operating instructions clearer and easier to understand. However, if you still have any questions on how to operate the equipment, please contact your dealer or the telephone hotline for your country. You will find the hotline telephone numbers printed at the back of this booklet.

Road safety

 Road safety has absolute priority. Only operate your radio unit if the road and traffic conditions allow you to do so. Familiarize yourself with the unit before setting off on your journey.

You should always be able to hear police, fire and ambulance sirens from far. For this reason, set the volume of the program you are listening to at a reasonable level.

Installation

If you want to install your car radio by yourself, please read the installation and connection instructions that follow these operating instructions.

Accessories

Only use accessories approved by Blaupunkt.

Remote control

The RC 04 remote control is optionally available for the Lexington C32 unit.

The St. Louis C32 unit cannot be remotely controlled.

Amplifier

All Blaupunkt and Velocity amplifiers can be used.

CD changer

The Blaupunkt CD changer CDC A 01 (7607 700 022) can be connected to the Lexington C32 unit.

No CD changer can be connected to the St. Louis C32 unit.

Removable control panel

Theft protection

As a way of protecting your equipment against theft, the unit is equipped with a detachable control panel (release panel). Without this control panel, the car radio is worthless to a thief.

Protect your equipment against theft by taking the control panel with you every time you leave your vehicle. Do not leave the control panel in your vehicle - not even in a hiding place.

The control panel has been designed to be easily use.

Note:

- Never drop the control panel.
- Never expose the control panel to direct sunlight or other heat sources.
- Avoid making direct skin contact with the control panel's contacts. If necessary, clean the contacts with a lint-free cloth and some alcohol.

Detaching the control panel

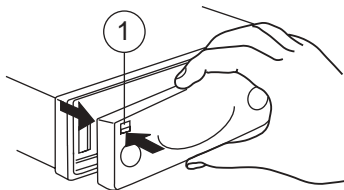

- ⇨ Press the **[V]** button (1).

The control panel locking mechanism opens.

- ⇨ First, pull the control panel straight off the unit and then out towards the left.
- The unit switches off after the control panel is removed.
- All current settings of the radio are saved.
- CD already inserted in the unit remains there.

Attaching the control panel

- ⇨ Slide the control panel from left to right into the unit's guide.
- ⇨ Press the left-hand edge of the control panel into the unit until it clicks into place.

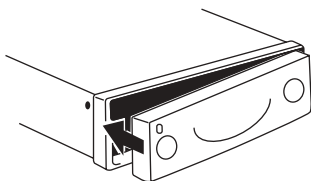

Note:

- When attaching the control panel, make sure you do not press on the display.

If the unit was still switched on when you removed the control panel, the unit will automatically switch back on with the last settings activated i.e. radio, CD or CC changer (CD changer only with the Lexington C32) when the panel is reinserted.

SWITCHING ON/OFF

Switching on/off

There are various ways of switching the unit on/off:

Switching on/off using the vehicle ignition

If the unit is correctly connected to the vehicle's ignition and it was not switched off using button ②, it will switch on/off simultaneously with the ignition.

Switching on/off using the removable control panel

⇨ Remove the control panel.

The unit switches off.

⇨ Attach the control panel again.

The unit switches on. The last settings i.e. radio, CC or CD changer (CD changer only with the Lexington C32) will be reactivated.

Switching on/off using button ②

⇨ To switch the unit on, press button ②.

The unit can only be switched on when the ignition is turned on.

⇨ To switch the unit off, press button ② for longer than two seconds.

The unit switches off.

ADJUSTING THE VOLUME

Adjusting the volume

The system volume can be adjusted in steps from 0 (off) to 100 (maximum).

To increase the system volume,

⇨ turn the volume control ③ clockwise.

To decrease the volume,

⇨ turn the volume control ③ anti-clockwise.

Setting the power-on volume

You can set the unit's default power-on volume.

⇨ Press the **MENU** button ⑧.

⇨ Keep pressing the **⏏** or **⏏** button ⑧ until "ON VOL" appears in the display.

⇨ Set the power-on volume using the **<** and **>** buttons ⑧.

To help you adjusting the volume more easily, the volume will be increased / decreased as you make your changes.

When you have finished making your changes,

⇨ press the **MENU** button ⑧ twice.

Instantaneously reducing the volume (mute)

You can instantaneously reduce the volume (mute) to a level preset by you.

⇨ Briefly press button ②.

"MUTE" appears in the display.

Setting the mute level

You can set the unit's mute volume level.

- ⇒ Press the **MENU** button (8).
- ⇒ Keep pressing the **▲** or **▼** button (8) until "MUTE LVL" appears in the display.
- ⇒ Set the mute level using the **<** and **>** buttons (8).

When you have finished making your changes,

- ⇒ press the **MENU** button (8) twice.

Mute while telephoning

If your unit is connected to a mobile telephone, the car radio's volume will be muted as soon as you "pick up" the telephone. "TEL CALL" flashes in the display.

This requires to the mobile telephone be connected to the car radio as described in the installation instructions.

The volume will be reduced to the configured mute volume level.

Radio mode

Switching to radio mode

If you are in CC or CD changer mode (CD changer only with the Lexington C32),

- ⇒ keep pressing the **SOURCE** (9) button until the radio mode appears in the display together with the memory bank and frequency.

Selecting the frequency band / memory bank

This unit can receive programs broadcast over the FM and AM frequency band. There are three preset memory bank for the FM range and one for the AM range. Six stations can be stored on each memory bank.

Selecting the FM memory bank

To switch between the FM memory bank FM1, FM2 and FMT,

- ⇒ press the **BAND/TS** button (13).

Selecting the AM waveband

To select the AM waveband,

- ⇒ keep pressing the **BAND/TS** button (13) until AM appears in the display.

RADIO MODE

Tuning into a station

There are various ways of tuning to a station.

Automatic seek tuning

⇨ Press the **√** or **⏏** button (8).

The unit tunes to the next receivable station.

Setting the sensitivity of station seek tuning

You can choose whether to tune only to strong reception stations or to also tune to those with a weak reception.

⇨ Press the **MENU** button (8).

⇨ Keep pressing the **√** or **⏏** button (8) until "SENS HI" or "SENS LO" appears in the display

"SENS HI" means that the tuner is set high to sensitivity. "SENS LO" means it is set to the low sensitivity setting. If "SENS LO" is selected, "LOC" lights up in the display.

⇨ Set the required sensitivity using the **<** and **>** buttons (8).

When you have finished making your changes,

⇨ press the **MENU** button (8).

Tuning into stations manually

You can also tune into stations manually.

⇨ Press the **<** or **>** button (8).

Storing station presets

Storing stations manually

⇨ Select the required memory bank (FM1, FM2 or FMT) or the AM waveband.

⇨ Tune into the station.

⇨ Press one of the station buttons **1-6** (12) for longer than one second to store the station in that preset memory.

Storing stations automatically (Travelstore)

You can automatically store the six stations with the strongest reception in the region. The stations are stored in the FMT or AM memory depending on the selected frequency band.

Note:

● Any stations that were previously stored on this memory bank are deleted in the process.

⇨ Press and hold the **BAND/TS** button (13) until seek tuning begins.

The station storing procedure begins. Once the procedure finishes, all the stored stations are played briefly.

Listening to station presets

⇨ Select the memory bank on which the station was stored.

⇨ Press the preset station button **1-6** (12) of the station you want to listen to.

Cassette mode

Cassette playback

- If there is no cassette inserted in the unit.
- ⇒ Insert the cassette with its open edge on the right and side A/1 facing up into the cassette compartment (5).

The side of the cassette that is facing up is then played first of all (side A/1). The cassette symbol appears in the display.

- If a cassette is already inserted in the unit.
- ⇒ Keep pressing the **SOURCE** button (9) until "TAPE" appears in the display.

The cassette is played in the direction that was last set.

Switching over the playing side of the tape

- ⇒ Press the tape-winding buttons **FR** (6) and **FF** (7) simultaneously.

The tape playing direction changes.

The direction of play is automatically switched over when the end of the tape is reached (autoreverse).

Fast tape winding

Fast-forwarding

- To fast forward side A/1,
 - ⇒ press the **FF** tape-winding button (7) so that it clicks into position.
- To fast forward side B/2,
 - ⇒ press the **FR** tape-winding button (6) so that it clicks into position.

"TAPE FF" appears in the display.

Fast-rewinding

- To fast rewind side A/1,
 - ⇒ press the **FR** tape-winding button (6) so that it clicks into position.
- To fast rewind side B/2,
 - ⇒ press the **FF** tape-winding button (7) so that it clicks into position.

"TAPE FR" appears in the display.

Stopping tape winding

- ⇒ Press the fast tape-winding button for the opposite direction.

Playback is resumed.

Cassette eject

- ⇒ Press the **⏏** button (4) to eject the cassette from the unit.

CD CHANGER MODE

CD changer mode

You can connect a CD changer to the Lexington C32 unit. You can obtain further information on available CD changers from your dealer.

Note:

- Information on handling CDs, inserting CDs and operating the CD changer can be found in the operating instructions supplied with your CD changer.

Switching to CD changer mode

- Keep pressing the **SOURCE** (9) button until the display shows, for instance, "CDC 1--1".

The first digit in this display represents the CD number (in this case 1), and the second digit represents the track number (in this case 1).

Playback begins with the first CD that the CD changer detects.

Selecting CDs

To move up or down to another CD,

- press the **▲** or **▼** button (8) once or several times.

Selecting tracks

To move up or down to another track on the current CD,

- press the **>** or **<** button (8) once or several times.

Fast searching (audible)

To fast search backwards or forwards,

- keep one of the **<>** buttons (8) pressed until fast searching backwards / forwards begins.

Repeating individual tracks or whole CDs (REPEAT)

To repeat the current track,

- briefly press button **3 (RPT)** (12).

"S--RPT" appears briefly in the display.

To repeat the current CD,

- keep the **3 (RPT)** button (12) pressed for longer than two seconds.

"D--RPT" appears briefly in the display.

Deactivating REPEAT

To stop the current track or current CD from being repeated,

- press button **3 (RPT)** (12) until "S--RPT" or "D--RPT" disappears and the standard CD changer display reappears.

Random track play (MIX)

To play the tracks on the current CD in random order,

⇨ briefly press button **4 (MIX)** (12).

“S--MIX” appears briefly in the display.

To play the tracks on all inserted CDs in random order,

⇨ keep the **4 (MIX)** button (12) pressed for longer than two seconds.

“D--MIX” appears briefly in the display.

Canceling MIX

To stop the tracks from being played in random order,

⇨ press button **4 (MIX)** (12) until “S--MIX” or “D--MIX” disappears and the standard CD changer display reappears.

Scanning all tracks on all CDs (SCAN)

Scanning tracks on the current CD

To briefly play all the tracks on the current CD in ascending order,

⇨ press button **2 (SCAN)** (12).

“S--SCN” appears in the display.

Scanning the first track on all CDs

You can briefly play the first track all CDs in the CD changer.

⇨ keep the **2 (SCAN)** button (12) pressed for longer than two seconds.

“D--SCAN” appears in the display.

Stopping SCAN

To stop scanning,

⇨ briefly press the **2 (SCAN)** button (12) again.

The currently scanned track will then continue to be played normally.

Note:

- You can set the scanning time (scantime). For further details, read the section entitled “Setting the scantime” in the “CD mode” chapter.

Pausing playback (PAUSE)

⇨ Press button **1 (||▶)** (12).

“S--PAUSE” appears in the display.

Canceling pause

⇨ Press button **2 (||▶)** (12) while in pause mode.

Playback is resumed.

CLOCK - TIME

CLOCK - Time

Displaying the time

To display the time,

- ⇨ briefly press the **CLOCK** button (14).

Setting the clock

- ⇨ Press the **MENU** button (8).
- ⇨ Keep pressing the **▲** or **▼** button (8) until "CLOCKSET" appears in the display.
- ⇨ Press the **▶** button (8).

The time appears in the display. The minutes flash on and off and can be adjusted.

- ⇨ Adjust the minutes using the **▲/▼** buttons (8).

Once the minutes are set,

- ⇨ press the **<** button (8).

The hours flash on and off.

- ⇨ Adjust the hours using the **▲/▼** buttons (8).

When you have finished making your changes,

- ⇨ press the **MENU** button (8) twice.

Selecting 12/24-hour clock mode

- ⇨ Press the **MENU** button (8).
- ⇨ Keep pressing the **▲** or **▼** button (8) until "24 H MODE" or "12 H MODE" appears in the display.
- ⇨ Press the **<** or **>** button (8) to switch between the modes.

When you have finished making your changes,

- ⇨ press the **MENU** button (8).

Displaying the time when the unit is off and the ignition is on

To display the clock when the unit is off and the ignition is on,

- ⇨ press the **MENU** button (8).
- ⇨ Keep pressing the **▲** or **▼** button (8) until "CLOCK OFF" or "CLOCK ON" appears in the display.
- ⇨ Press the **<** or **>** button (8) to switch between the displays.

When you have finished making your changes,

- ⇨ press the **MENU** button (8).

Sound and volume distribution settings

Adjusting the bass

To adjust the BASS,

- ⇨ press the **AUDIO** button (10).

“BAS” appears in the display.

To increase the bass,

- ⇨ turn the volume control (3) clockwise.

To decrease the bass,

- ⇨ turn the volume control (3) anti-clockwise.

When you have finished making your changes,

- ⇨ wait 8 seconds, the settings are saved and the audio source display appears.

Adjusting the treble

To adjust the TREBLE,

- ⇨ keep pressing the **AUDIO** (10) button until “TRE” appears in the display.

To increase the treble,

- ⇨ turn the volume control (3) clockwise.

To decrease the treble,

- ⇨ turn the volume control (3) anti-clockwise.

When you have finished making your changes,

- ⇨ wait 8 seconds, the settings are saved and the audio source display appears.

Adjusting the balance settings

To adjust the left/right volume distribution (balance),

- ⇨ keep pressing the **AUDIO** (10) button until “BAL” appears in the display.

To move the volume distribution toward the right,

- ⇨ turn the volume control (3) clockwise.

To move the volume distribution toward the left,

- ⇨ turn the volume control (3) anti-clockwise.

When you have finished making your changes,

- ⇨ wait 8 seconds, the settings are saved and the audio source display appears.

Adjusting the fader settings

To adjust the front/back volume distribution (fader),

- ⇨ keep pressing the **AUDIO** (10) button until “FAD” appears in the display.

To move the volume distribution toward the back,

- ⇨ turn the volume control (3) clockwise.

To move the volume distribution toward the front,

- ⇨ turn the volume control (3) anti-clockwise.

When you have finished making your changes,

- ⇒ wait 8 seconds, the settings are saved and the audio source display appears.

Equalizer and X-BASS

X-BASS

The X-BASS feature can be used to boost the bass at low volume levels.

To activate X-BASS,

- ⇒ keep the **EQ/X-BASS** button (11) pressed until "XBASS ON" appears in the display.

"X-BASS" appears in the display.

To deactivate X-BASS,

- ⇒ keep the **EQ/X-BASS** button (11) pressed until "XBASS OFF" appears in the display.

"X-BASS" disappears.

Selecting preset sound effect

You can select preset sound effect for the following styles of music:

- CLASSIC
- POP M
- ROCK M

The settings for these music styles have already been programmed.

To select one of the sound presets,

- ⇒ keep pressing the **EQ/X-BASS** button (11) until the required setting appears in the display.

If you want to deactivate the sound preset,

- ⇒ keep pressing the **EQ/X-BASS** button (11) until "DSP OFF" appears in the display.

Specifications

Amplifier

Output power:

St. Louis C32:	4 x 22 watts sine in accordance with DIN 45 324 at 14.4 V 4 x 50 watts max. power
Lexington C32:	4 x 15 watts sine in accordance with DIN 45 324 at 14.4 V 4 x 40 watts max. power

Tuner

Frequency ranges US:

FM:	87.5 - 107.9 MHz
AM:	530 - 1710 kHz

FM mono sensitivity:

15 dBf

FM frequency response:

35 - 16.000 Hz

CC

Frequency response:

30 - 18.000 Hz

Pre-Amp Out

(not applicable to St. Louis C32:)

Output: $1.5 V_{\text{rms}} \pm 2.5 \text{ dB}$

Subject to changes!

Service numbers / Numéros du service après-vente / Números de servicio / Número de serviço

Country:	Phone:	Fax:	WWW:
Germany	(D) 0180-5000225	05121-49 4002	http://www.blaupunkt.com
Austria	(A) 01-610 390	01-610 393 91	
Belgium	(B) 02-525 5454	02-525 5263	
Denmark	(DK) 44 898 360	44-898 644	
Finland	(FIN) 09-435 991	09-435 99236	
France	(F) 01-4010 7007	01-4010 7320	
Great Britain	(GB) 01-89583 8880	01-89583 8394	
Greece	(GR) 0800-550 6550	01-576 9473	
Ireland	(IRL) 01-4149400	01-4598830	
Italy	(I) 02-369 6331	02-369 6464	
Luxembourg	(L) 40 4078	40 2085	
Netherlands	(NL) 023-565 6348	023-565 6331	
Norway	(N) 66-817 000	66-817 157	
Portugal	(P) 01-2185 00144	01-2185 11111	
Spain	(E) 902-120234	916-467952	
Sweden	(S) 08-7501500	08-7501810	
Switzerland	(CH) 01-8471644	01-8471650	
Czech. Rep.	(CZ) 02-6130 0441	02-6130 0514	
Hungary	(H) 01-333 9575	01-324 8756	
Poland	(PL) 0800-118922	022-8771260	
Turkey	(TR) 0212-3350677	0212-3460040	
USA	(USA) 800-2662528	708-6817188	
Brasil (Mercosur)	(BR) +55-19 3745 2769	+55-19 3745 2773	
Malaysia (Asia Pacific)	(MAL) +604-6382 474	+604-6413 640	

Blaupunkt GmbH





Radio / Cassette

Lexington C32 St. Louis C32

Installation instructions
Notice de montage
Instrucciones de instalación
Instruções de montagem



<http://www.blaupunkt.com>

 **BLAUPUNKT**

Installation instructions • Notice de montage • Instrucciones de instalación • Instruções de montagem

Safety precautions

Installation and connection regulations

- In the event that this equipment is installed or repaired incorrectly, this could cause malfunctions in the vehicle electronics.
- To avoid causing damage to your radio, use the corresponding Blaupunkt adapter cable to connect the 8-pin +/- ISO plug in the vehicle.

While installing and connecting this equipment, please observe the following safety notes:

- Disconnect the negative battery terminal.
- Observe the car manufacturer's safety instructions.
- If you drill any holes, make sure that you do not damage any parts of the vehicle.
- The diameter of the positive/negative cable must not be less than 1.5 mm².

Indications de sécurité

Consignes de montage et de branchement

- En cas d'erreur d'installation ou d'entretien, des perturbations peuvent survenir au niveau des systèmes électroniques du véhicule.
- Pour ne pas détériorer votre autoradio, branchez le connecteur ISO +/- 8 pôles du véhicule uniquement via un câble adaptateur Blaupunkt correspondant.

Pendant le montage et le branchement, observez les consignes de sécurité suivantes :

- Débrancher le pôle (-) de la batterie.
- Observer ce faisant les indications de sécurité du constructeur automobile.
- Veiller à ne pas endommager les pièces du véhicule en perçant des trous.
- La section transversale du câble (+) et (-) ne doit pas être inférieure à 1,5 mm².

(E) ⚠ Normas de seguridad

Especificaciones sobre la instalación y conexión

- En caso de realizarse una instalación o un mantenimiento inadecuado, éstos pueden ocasionar fallos en las funciones de los sistemas eléctricos del vehículo.
- Para que su radio no sufra daños, debe conectar el enchufe del vehículo de 8 polos +/- ISO sólo al correspondiente cable adaptador Blaupunkt.

Durante el montaje y la conexión observe las siguientes normas de seguridad.

- Desemborne el polo negativo de la batería.
- Al hacerlo, observe las normas de seguridad del fabricante del vehículo.
- Al taladrar orificios asegúrese de que el vehículo no sufra ningún daño.
- El diámetro del cable positivo y negativo no debe ser menor a 1,5 mm².

(P) ⚠ Indicações de segurança

Directivas de montagem e de conexão

- Podem ocorrer erros de funcionamento em sistemas electrónicos de automóveis devido à uma instalação ou manutenção errada.
- Para evitar a destruição do seu rádio, deverá apenas ligar a ficha ISO de 8 pólos do automóvel através de um respectivo cabo de adaptação Blaupunkt.

Observe por favor as seguintes indicações de segurança durante a montagem e a ligação

- Separar por pressão o pólo negativo da bateria.
- Observar as indicações de segurança do fabricante do automóvel.
- Ao furar orifícios, deverá observar que não sejam danificadas partes do automóvel.
- O diâmetro do cabo positivo e negativo não deve ser inferior a 1,5 mm².

Supplied Mounting Hardware

Matériel de montage fourni

Ferreteria de montaje suministrada

Elementos de fixação fornecidos

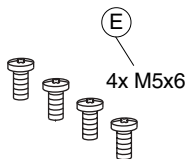
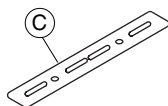
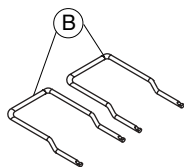
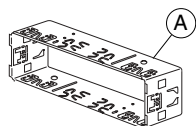

1.

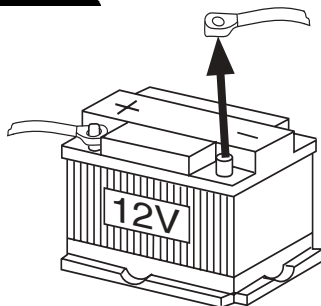

2.

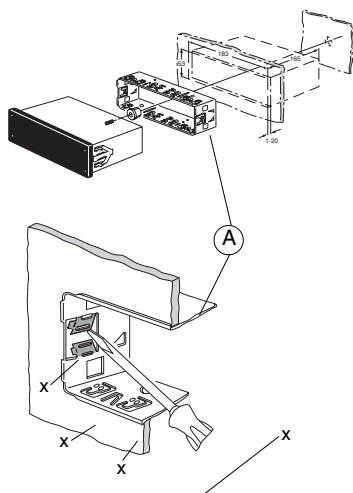

Bend as many taps as possible.

Plier si possible toutes les attaches.

Lo ideal es poder doblar todas las bridas de sujeción.

Devem ser dobradas o máximo possível de braçadeiras.

3.

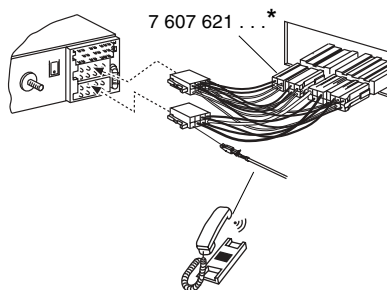

* Car-specific adapter cable which is available at your dealer.

Câble adaptateur spécifique au véhicule, disponible dans le commerce.

Adaptador específico del vehículo, el cual se puede adquirir en el comercio especializado.

Cabo de adaptação específico do automóvel que pode ser adquirido no comércio especializado.

4.

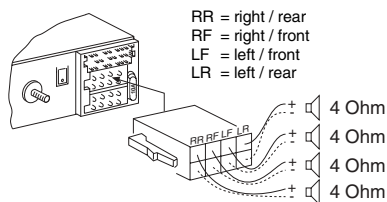

5.

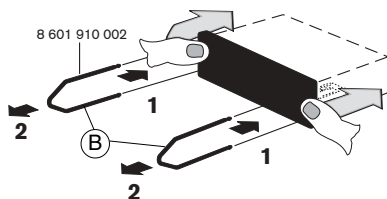

6.

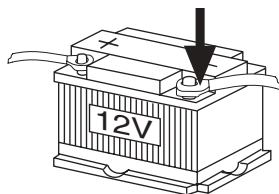

ENGLISH

FRANÇAIS

ESPAÑOL

PORTUGUÊS

7.

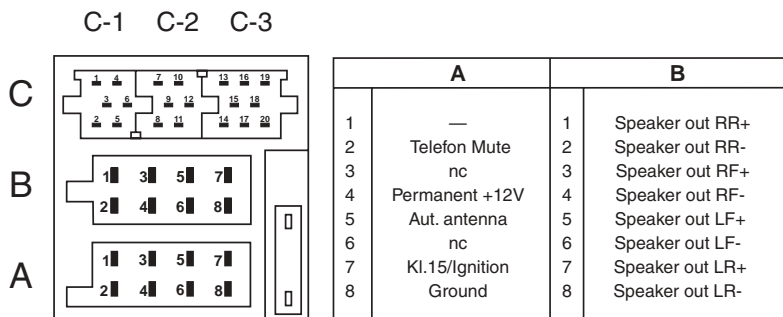

C					
C1		C2		C3	
1	Line Out LR 5V/10K	7	nc	13	Changer Bus
2	Line Out RR 5V/10K	8	nc	14	nc
3	Line Out Masse / Ground	9	nc	15	+12V
4	nc	10	nc	16	12V
5	nc	11	nc	17	Changer GND
6	nc	12	nc	18	AF - GND
				19	Line In - L 1,2V/10K
				20	Line In - R 1,2V/10K

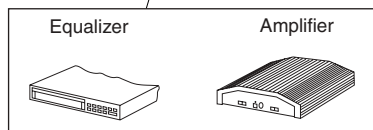

only
Lexington C 32



only
Lexington C 32

8.

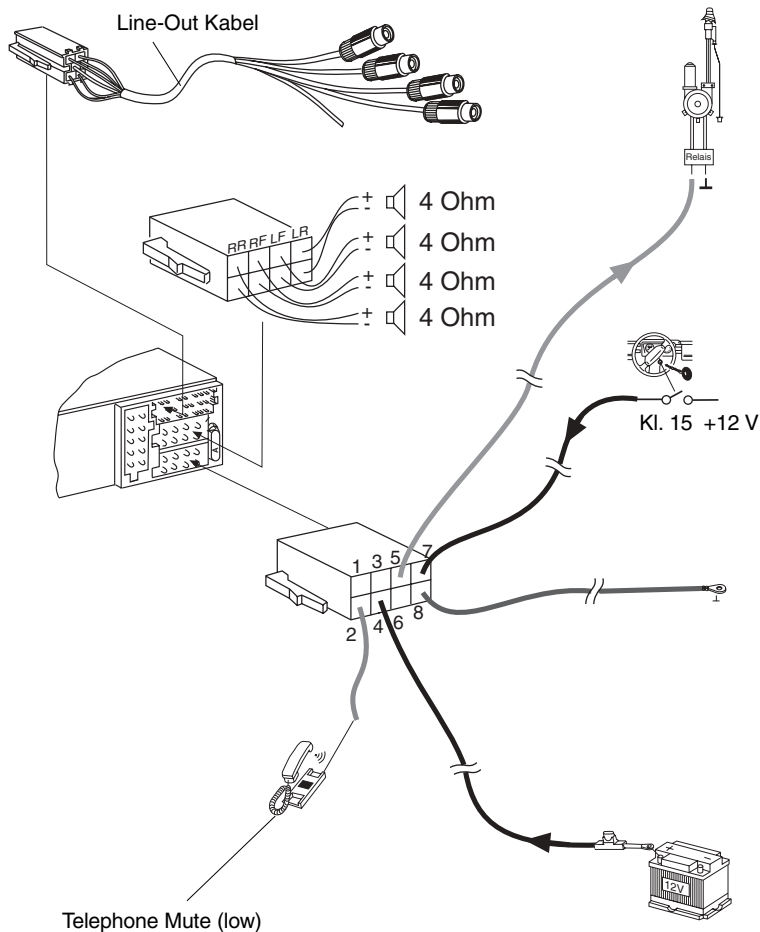

ENGLISH

FRAANÇAIS

ESPAÑOL

PORTUGUÊS

This information is subject to change without notice!

Sous réserve de modifications!

Modificaciones reservadas!

Sob reserva de alterações!